

Spezifikation für Freigabe / specification for release

Kunde / customer :

Artikelnummer / part number :

744065560



Bezeichnung : **SPEICHERDROSSEL WE-TPC**

description : **POWER-CHOKE WE-TPC**

DATUM / DATE : 2008-04-11

A Mechanische Abmessungen / dimensions :

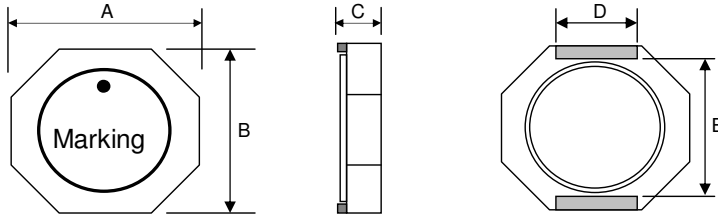

	Typ XL	
A	10 ± 0,3	mm
B	10 ± 0,3	mm
C	2,8 ± 0,3	mm
D	3,2 ref.	mm
E	7,4 ref.	mm

● = Start of winding Marking = Inductance code

B Elektrische Eigenschaften / electrical properties :

Eigenschaften / properties	Testbedingungen / test conditions		Wert / value	Einheit / unit	tol.
Induktivität / inductance	100 kHz / 1,0V	L	56,00	μH	± 30%
DC-Widerstand / DC-resistance	@ 20°C	R _{DC typ}	210,00	mΩ	typ.
DC-Widerstand / DC-resistance	@ 20°C	R _{DC max}	270,00	mΩ	max.
Nennstrom / rated current	ΔT=30 K	I _{DC}	1,25	A	max.
Sättigungsstrom / saturation current	 ΔL/L <35%	I _{sat}	1,10	A	typ.
Eigenres.-Frequenz / self-res.-frequency		SRF	10,0	MHz	typ.

C Lötpad / soldering spec. :

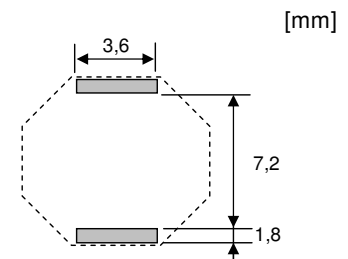

D Prüfgeräte / test equipment :

HP 4274 A für/for L und/and SRF

HP 34401 A für/for I_{DC} und/and R_{DC}

E Testbedingungen / test conditions :

Luftfeuchtigkeit / humidity: 33%
Umgebungstemperatur / temperature: +20 °C

F Werkstoffe & Zulassungen / material & approvals :

Basismaterial / base material: Ferrit / ferrite
 Draht / wire: Class H
 Endoberfläche / finishing electrode: Sn/Ag/Cu - 96.5/3.0/0.5%

G Eigenschaften / general specifications :

Betriebstemp. / operating temperature: -40 °C - + 125 °C
 Umgebungstemp. / ambient temperature: -40 °C - + 85 °C
 It is recommended that the temperature of the part does not exceed 125 °C under worst case operating conditions.

Freigabe erteilt / general release:	Kunde / customer		
Datum / date	Unterschrift / signature		
	Würth Elektronik		
Geprüft / checked	Kontrolliert / approved		
	MST	Version 2	08-04-11
	ME	Version 1	04-10-11
	Name	Änderung / modification	Datum / date

Würth Elektronik eiSos GmbH & Co. KG

D-74638 Waldenburg · Max-Eyth-Strasse 1 - 3 · Germany · Telefon (+49) (0) 7942 - 945 - 0 · Telefax (+49) (0) 7942 - 945 - 400
<http://www.we-online.de>

Spezifikation für Freigabe / specification for release

Kunde / customer :

Artikelnummer / part number : **744065560**

Bezeichnung : **SPEICHERDROSSEL WE-TPC**

description : **POWER-CHOKE WE-TPC**



DATUM / DATE : 2008-04-11

H Induktivitätskurve / Inductance curve :

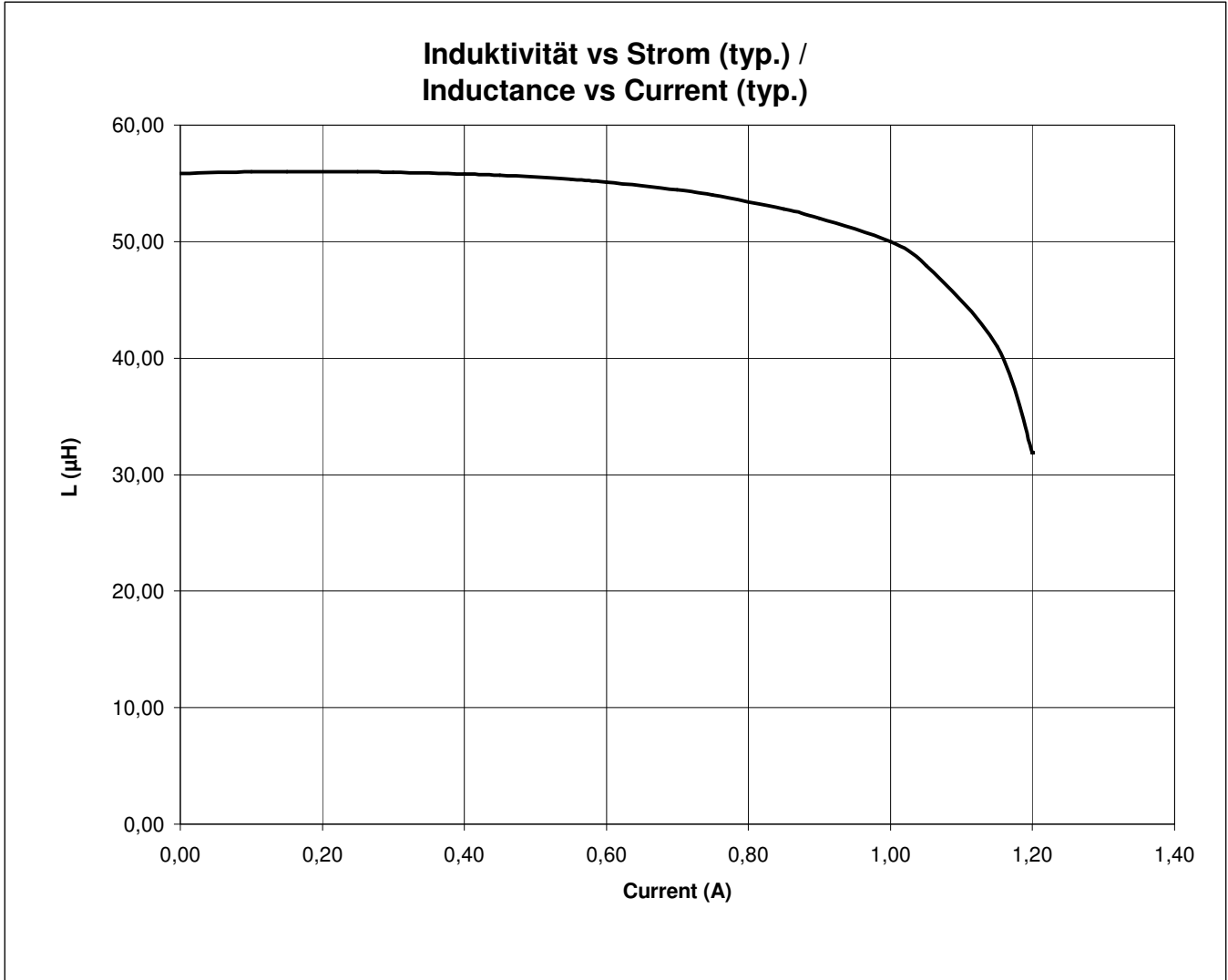

Freigabe erteilt / general release:	Kunde / customer			
.....			
Datum / date	Unterschrift / signature			
	Würth Elektronik			
.....	MST	Version 2	08-04-11
Geprüft / checked	Kontrolliert / approved	ME	Version 1	04-10-11
		Name	Änderung / modification	Datum / date

Würth Elektronik eiSos GmbH & Co. KG

D-74638 Waldenburg · Max-Eyth-Strasse 1 - 3 · Germany · Telefon (+49) (0) 7942 - 945 - 0 · Telefax (+49) (0) 7942 - 945 - 400
<http://www.we-online.de>

Spezifikation für Freigabe / specification for release

Kunde / customer :

Artikelnummer / part number :

744065560

LF



Bezeichnung : **SPEICHERDROSSEL WE-TPC**

description : **POWER-CHOKE WE-TPC**

DATUM / DATE : 2008-04-11

I Rollenspezifikation / Tape and reel specification :

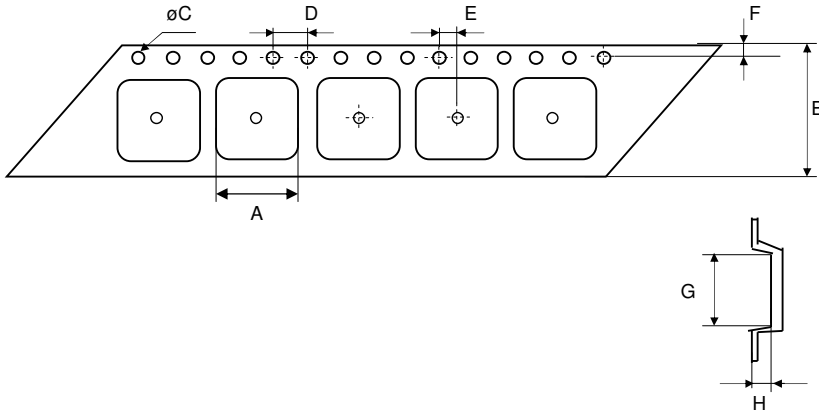

Gurtspezifikation / Tape specification:		
A	6,6 ± 0,1	mm
B	16,0 ± 0,3	mm
C	1,50 ± 0,1	mm
D	4,00 ± 0,1	mm
E	2,00 ± 0,1	mm
F	1,75 ± 0,1	mm
G	7,00 ± 0,1	mm
H	3,40 ± 0,1	mm

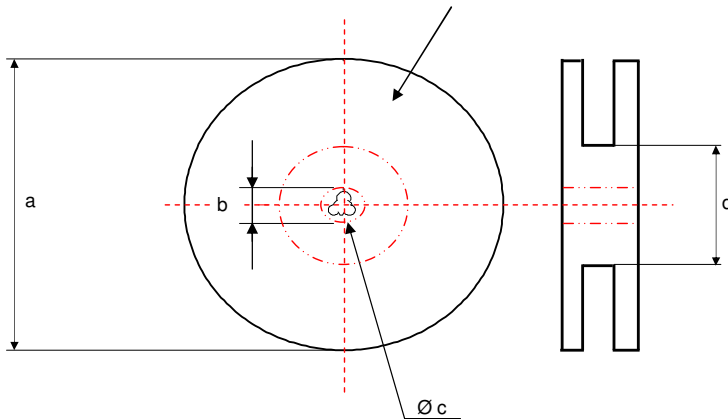

Rollenspezifikation / Reel specification:		
a	330,0 ± 0,5	mm
b	20,20 ± 0,1	mm
c	13,00 ± 1,0	mm
d	100,0 ± 1,0	mm

Freigabe erteilt / general release:	Kunde / customer		
Datum / date	Unterschrift / signature		
	Würth Elektronik		
Geprüft / checked	Kontrolliert / approved		
	MST	Version 2	08-04-11
	ME	Version 1	04-10-11
	Name	Änderung / modification	Datum / date

This electronic component has been designed and developed for usage in general electronic equipment. Before incorporating this component into any equipment where higher safety and reliability is especially required or if there is the possibility of direct damage or injury to human body, for example in the range of aerospace, aviation, nuclear control, submarine, transportation, (automotive control, train control, ship control), transportation signal, disaster prevention, medical, public information network etc, Würth Elektronik eiSos GmbH must be informed before the design-in stage. In addition, sufficient reliability evaluation checks for safety must be performed on every electronic component which is used in electrical circuits that require high safety and reliability functions or performance.

Würth Elektronik eiSos GmbH & Co. KG

D-74638 Waldenburg · Max-Eyth-Strasse 1 - 3 · Germany · Telefon (+49) (0) 7942 - 945 - 0 · Telefax (+49) (0) 7942 - 945 - 400
<http://www.we-online.de>